

Übersicht Verbinder + Nuten / Overview fittings + grooves

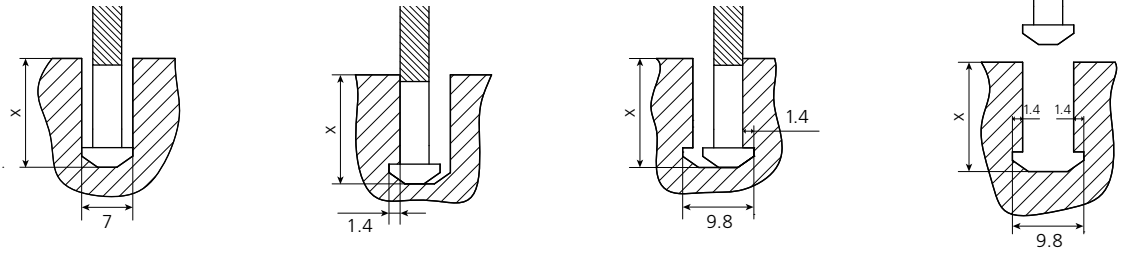

## Clamex P-14

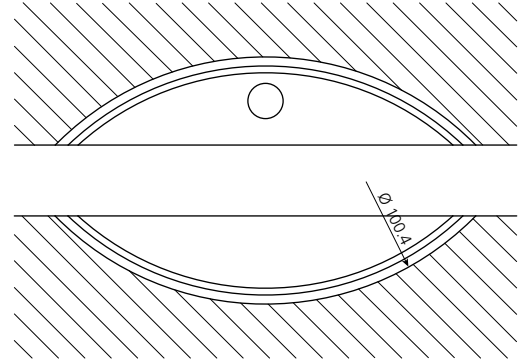
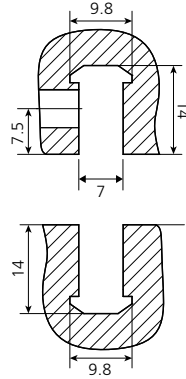
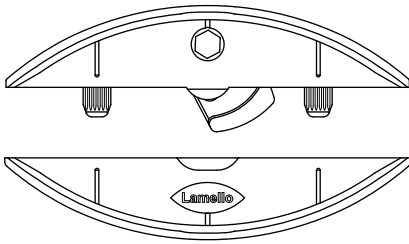

## Clamex P-Medius 14/10

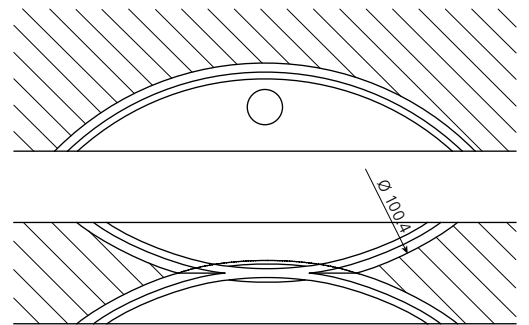
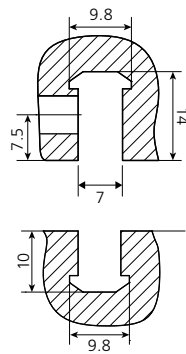
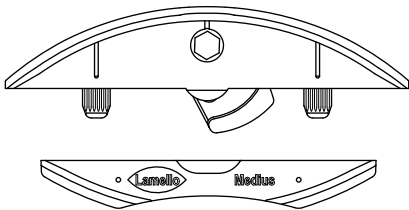

## Clamex P-14, Halbschale mit Hebel / element with the lever

## Clamex P-10, Halbschale ohne Hebel / element without lever

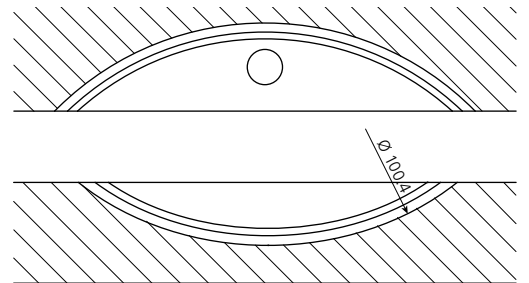
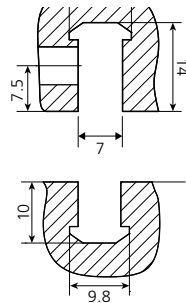
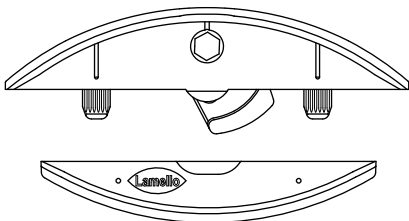

## Clamex P-10

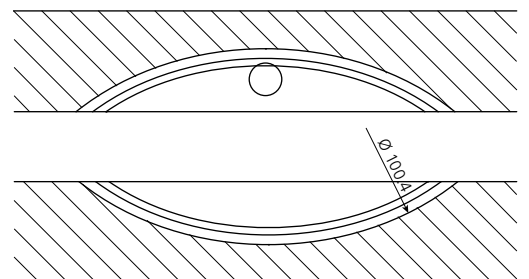
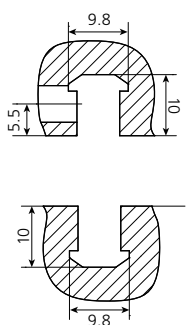
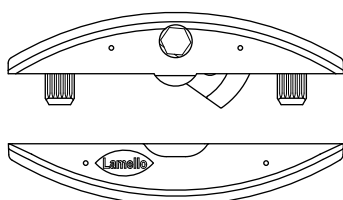

## Tenso P-14

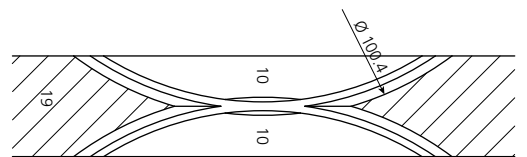
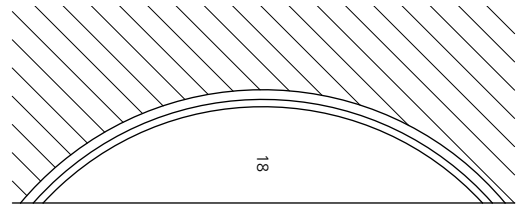
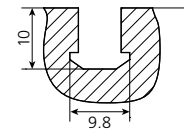
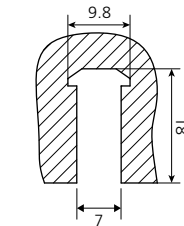
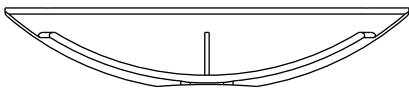
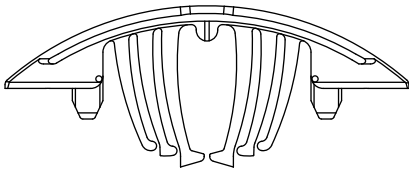
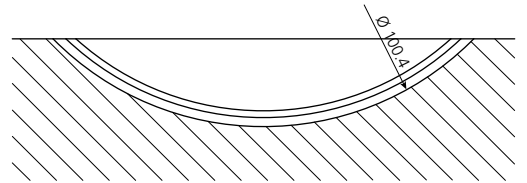
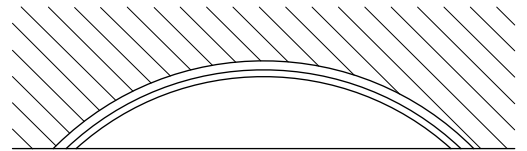
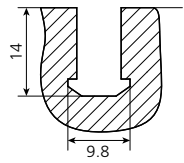
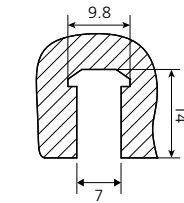
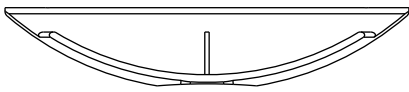
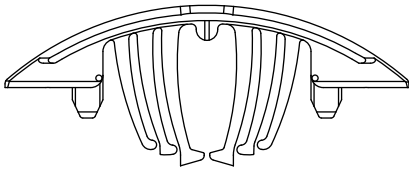

## Bisco P-14

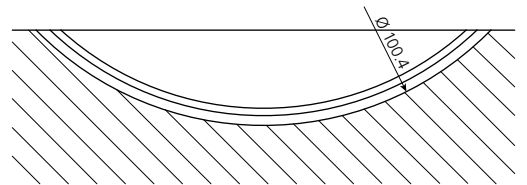
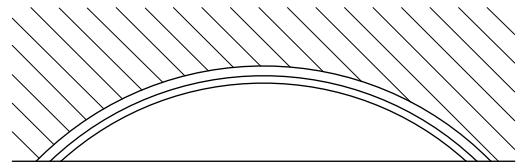
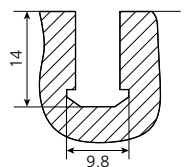
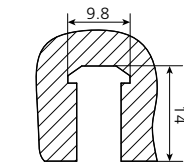
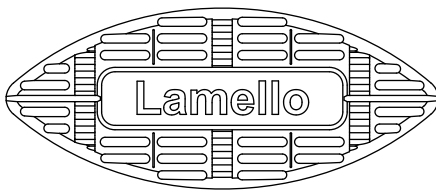

## Bisco P-10

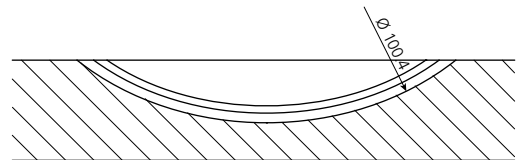
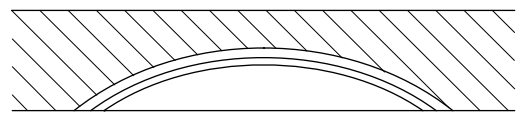
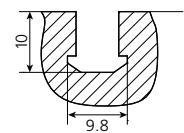
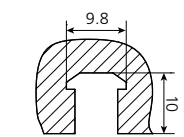
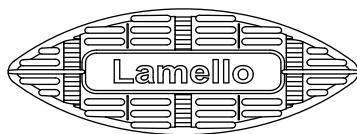

## Divario P-18

