

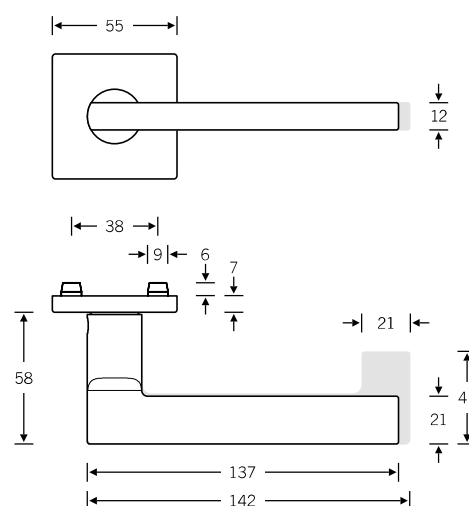

De Düsseldorfse binnenhuisarchitecte Heike Falkenberg vroeg FSB in de herfst van 1996 om voor een renovatieopdracht een ouder greepontwerp een nieuwe look te geven. Op basis van de ontvangen schetsen freesde de FSB ontwikkelingsafdeling een prototype uit model FSB 1076. Onlangs nieuw geïnterpreteerd met hoekige rozet.



Design: Heike Falkenberg

 EN 179-model: FSB 1031  
Deurkruk met return

Overige uitvoeringen:  
– ronde rozetten  
– ovale/rechthoekige  
schilden

Rozetloze deurkruk

15 1035

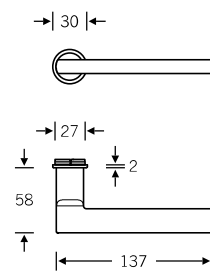

4

Raamkruk

Rozetloze raamkruk

34 1035

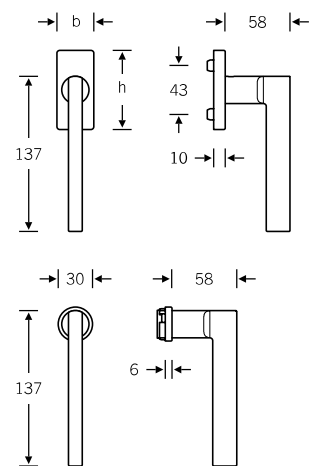

Individueel afgestemde hef-schuifdeur-greep op aanvraag, zie pagina 10

## Profieldeurkrukken

09 1031 (recht, EN 179)  
06 1031 (verkropt, EN 179)

Optioneel zonder return:  
09 1035 (recht)  
06 1035 (verkropt)



Afb. 09 1031



Afb. 09 1035

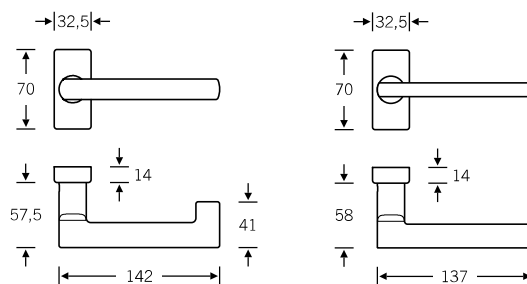

Afb. 06 1031



Afb. 06 1035

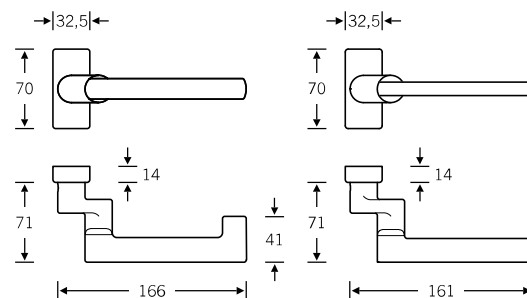

## Profieldeurknop

07 0812 (verkropt)

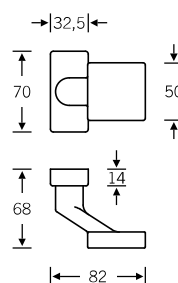

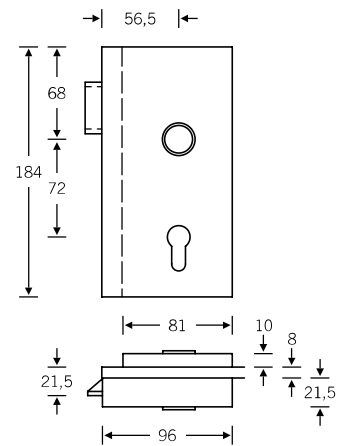

Wisselgarnituren

Deurknop voor houten deuren

Knopschilden

Aluminium Ø = 50  
Roestvrij staal Ø = 55

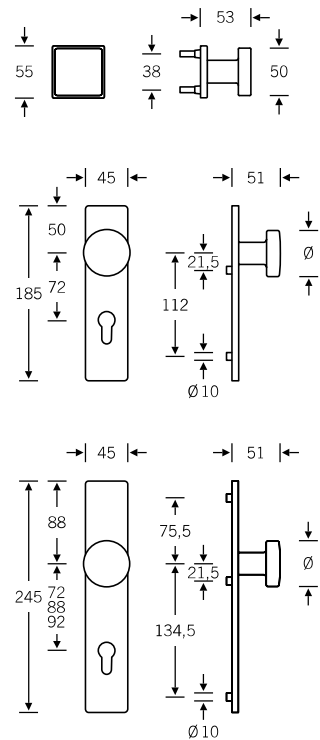

Artikelnummers van de wisselgarnituren op de volgende dubbele pagina, afzonderlijke componenten zie pagina 328 e. v.

## Deurkrukgarnituren

Breedschildgarnituren op aanvraag;  
vlakliggende rozetten zie pagina 536 e. v.

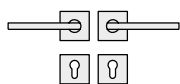

- 12 1035 041 (N)
- 72 1035 641 (R)
- 76 1035 639 (R)\*
- 79 1031 639 (R)
- 72 1035 642 (L)
- 76 1035 640 (L)\*
- 79 1031 640 (L)

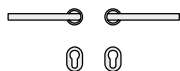

- 15 1035 013 (N)

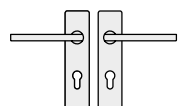

- 12 1035 001 (N)
- 72 1035 601 (R)
- 76 1035 601 (R)\*
- 79 1031 601 (R)
- 72 1035 602 (L)
- 76 1035 602 (L)\*
- 79 1031 602 (L)

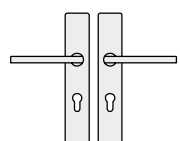

- 12 1035 021 (N)
- 72 1035 621 (R)
- 76 1035 621 (R)\*
- 79 1031 621 (R)
- 72 1035 622 (L)
- 76 1035 622 (L)\*
- 79 1031 622 (L)

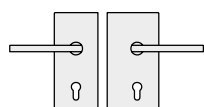

- 13 4220 041 (R) met 10 1035 00500 (N)
- 13 4220 042 (R) met 12 1035 041 (N)
- 13 4220 042 (R) met 72 1035 641 (R)
- 13 4220 090\*\* met 76 1035 639 (R)
- 13 4220 090\*\* met 79 1031 939 (N)
- 13 4220 051 (L) met 10 1035 00500 (N)
- 13 4220 052 (L) met 12 1035 041 (N)
- 13 4220 052 (L) met 72 1035 642 (L)
- 13 4220 090\*\* met 76 1035 640 (L)

## Profieldeurgarnituren

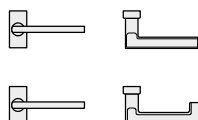

- 09 1035 271
- 09 1035 272
- 09 1031 272
- 09 1031 273 (sdg)\*

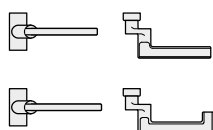

- 06 1035 171
- 06 1035 172\*
- 06 1031 172
- 06 1035 073 (sdg)\*
- 06 1031 073 (sdg)



- 07 0812 229 (vast, aluminium en roestvrij staal)
- 07 0812 229 (vast, roestvrij staal)
- 07 0812 429 (vast, aluminium)



- 17 1778

\* uitsluitend in roestvrij staal, conform ÖNorm ook in aluminium  
 \*\* brandwerende en EN 179-uitvoering uitsluitend leverbaar in roestvrij staal, uitvoeringen zie pagina 508

## Wisselgarnituren

Breedschildgarnituren op aanvraag;  
vlakliggende rozetten zie pagina 536 e. v.

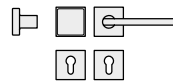

- |                   |                  |
|-------------------|------------------|
| 12 1035 043 (N)   | 72 1035 644 (L)  |
| 72 1035 643 (R)   | 76 1035 642 (L)* |
| 76 1035 641 (R)*  | 79 1031 642 (L)  |
| 79 1031 641 (R)   |                  |
| 79 1031 643 (sdg) |                  |

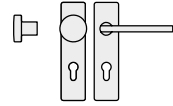

- |                   |                  |
|-------------------|------------------|
| 12 1035 003 (N)   | 72 1035 604 (L)  |
| 72 1035 603 (R)   | 76 1035 604 (L)* |
| 76 1035 603 (R)*  | 79 1031 604 (L)  |
| 79 1031 603 (R)   |                  |
| 79 1031 605 (sdg) |                  |

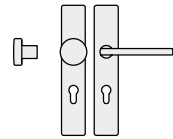

- |                   |                  |
|-------------------|------------------|
| 12 1035 023 (N)   | 72 1035 624 (L)  |
| 72 1035 623 (R)   | 76 1035 624 (L)* |
| 76 1035 623 (R)*  | 79 1031 624 (L)  |
| 79 1031 623 (R)   |                  |
| 79 1031 625 (sdg) |                  |

## WC-garnituren

Breedschildgarnituren op aanvraag;  
vlakliggende rozetten zie pagina 536 e. v.

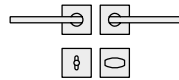

- |                 |                 |
|-----------------|-----------------|
| 12 1035 045 (N) | 72 1035 646 (L) |
| 72 1035 645 (R) |                 |

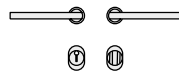

- |                 |
|-----------------|
| 15 1035 019 (N) |
|-----------------|

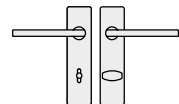

- |                 |                 |
|-----------------|-----------------|
| 12 1035 005 (N) | 72 1035 606 (L) |
| 72 1035 605 (R) |                 |

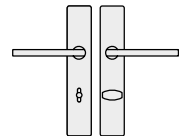

- |                 |                 |
|-----------------|-----------------|
| 12 1035 025 (N) | 72 1035 626 (L) |
| 72 1035 625 (R) |                 |

## Raamkrukken

Individueel afgestemde hef-schuifdeur-  
greep op aanvraag, zie pagina 10

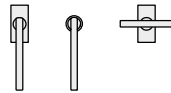

- 34 1035 09032 (rozet 27 × 62 × 10)
- 34 1035 09040 (rozet 32,5 × 70 × 10)
- 34 1035 09036 (rozet 25,5 × 60,5 vlakliggend)
- 34 1035 180 (sluitadapter RC 1–6)
- 34 1035 086 (sluitadapter, met drukknop RC 1–6)
- 34 1035 711 (rozetloze kruk, voor hout/metaal, Ø 30)
- 34 1035 751 (rozetloze kruk, voor kunststof, Ø 30)
- 34 3784 (kruisgreep)

N = richtingneutraal  
R = DIN rechts, naar binnen openend  
L = DIN links, naar binnen openend  
sdg = standdeurgarnituur

Deurkrukgedelen  
 Rozetloze deurkruk  
 FSB ASL®

FSB AGL®  
 Projectbeslag FS  
 Projectbeslag EN 179

Lagertechnologie zie pagina  
52 e. v.