

TORMEK - Slijpmal voor messen SVM-45

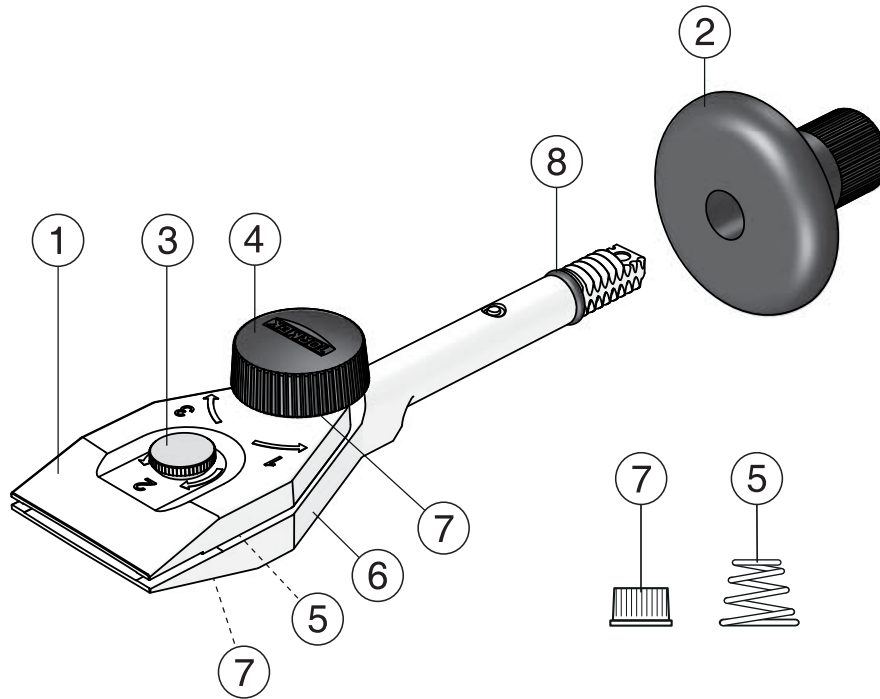

Nr.	Benaming	Gewicht
1	Klem	
2	Instelbare stop	22 gr.
3	Instelbare schroef	7 gr.
4	Aanhaalknop	9 gr.
5	Veer	0 gr.
6	Basis	
7	Koperen naaf	4 gr.
8	O-ring	1 gr.